

## Data Sheet

### Profi Line G6

### 25-Port Industrial GbE Ring Switch 19"



## Overview

Based on a robust design, the hardened Ruggedized 19" Gigabit Ethernet Switch from MICROSENS provides maximum performance and flexibility in smallest spaces. Engineered to achieve highest reliability and shortest recovery times, this MICROSENS switch family has become the first-choice solution for Industrial Ethernet infrastructures.

The hardware of the Ruggedized 19" Gigabit Ethernet Switch is already designed to deploy future functions which can be activated easily by firmware upgrades. This is facilitated by the latest high-performance switching chipsets in combination with a powerful ARM processor. As a well-established and stable operating system, Linux provides a solid foundation for an intelligent, open, secure, and long-term reliable platform.

## Highlights

- Highest Gigabit performance with smallest dimensions and fan-less cooling
  - Industrial design for maximum reliability in harsh environments
  - 25 Gigabit (8 of them with fiber) ports on only 1U in 19" racks
  - Optimised architecture for increased performance with parallel ring topology
  - Integrated PoE+ PSE provides up to 16 x 30 W power to Ethernet network devices (max. 480 W PSE Budget (MS400895MX))
  - Range of ambient operation temperature from -40 up to +85 °C
  - Exchangeable SD-card for firmware and configuration
- Flexible firmware architecture for simple software upgrades

## Specifications

### Gigabit Ethernet Switch

---

- Fanless Gigabit Ethernet Switch
- Low power consumption switch-chipset, Energy-Efficient Ethernet
- Layer-2+ store-and-forward
- Max. 8,192 MAC-addresses, automatic learning and aging
- Jumbo-Frames (max. 10,240 Bytes)

### Energy-Efficient Ethernet

---

- EEE according to IEEE 802.3az
- Reduced power consumption for each RJ-45 port up to 80% depending on the actual requirement

### Network Management

---

- Support of common management standards
- High Performance 1000 MHz ARM CPU and Linux operating system with fast system boot
- Web Manager (HTTP/HTTPS)
- Telnet/SSH/Console, incl. standard-commands (ping, traceroute etc.)
- SNMP v1/v2c/v3 with View-based Access Control Model (VACM) and User-based Security Model (USM)
- Central management platform (MICROSENS NMP)
- IPv4/IPv6 Dual Stack
- Integrated CLI scripting for the automation of routine processes
- Firmware-, script- and configuration files can be loaded, stored and executed directly from the switch
- Incremental firmware updates
- Exchangeable SD memory card for configuration, CLI scripts, firmware

### Compatibility

---

- Verified to standard CISCO Switches (IEEE 802.1X, QoS, VLAN, CDP, RSTP)

### Mounting

---

- Mounting into 19" racks requiring 1U space

### Power-over-Ethernet PoE/PoE+

---

- 16x 10/100/1000Base-T, PoE/PoE+ (PSE, max. 30 W)
- 1x 10/100/1000Base-T, PoE+ (PD, max. 25 W)
- IEEE 802.3af PoE (max. 15 W/Port), power supply with typ. 48 VDC
- IEEE 802.3at PoE+ (max. 30 W/Port), power supply with typ. 54 VDC
- Max. PoE Budget: 240 W or 480 W (MS400895MX)
- Full power available under suitable installation conditions only

### Connectors (Base-Switch)

---

#### Up-/Downlinks (Dual Media-Ports)

- 8x SFP-Slot 100/1000Base-X or
- 8x 10/100/1000Base-T (RJ-45)

#### Local Ports

- 17x 10/100/1000Base-T (RJ-45) Auto-Negotiation
- Auto MDI/MDI-X function for the use of uniform patch cables

#### Power Supply

- 2x 3-pin screw pluggable connector for solid or stranded wires (1x 3-pin screw pluggable connector for MS400895MX)

#### RS-232 Console Port

- Serial terminal port for CLI access (outband management)
- RJ-45 connector

#### USB Extension Port

- For optional accessories

#### Alarm Contacts / I/O-Ports

- Potential free digital input/output ports
- 2x output (relay)
- 2x input (optocoupler)

## Feature overview network management

For the latest functional firmware features and supported IEEE / RFC standards, please refer to the document "[Firmware Features G6](#)" which can be downloaded from the download center of the particular device home pages at [www.microsens.de](http://www.microsens.de)

## Interfaces (MS400890MX-V2)

### Front View:

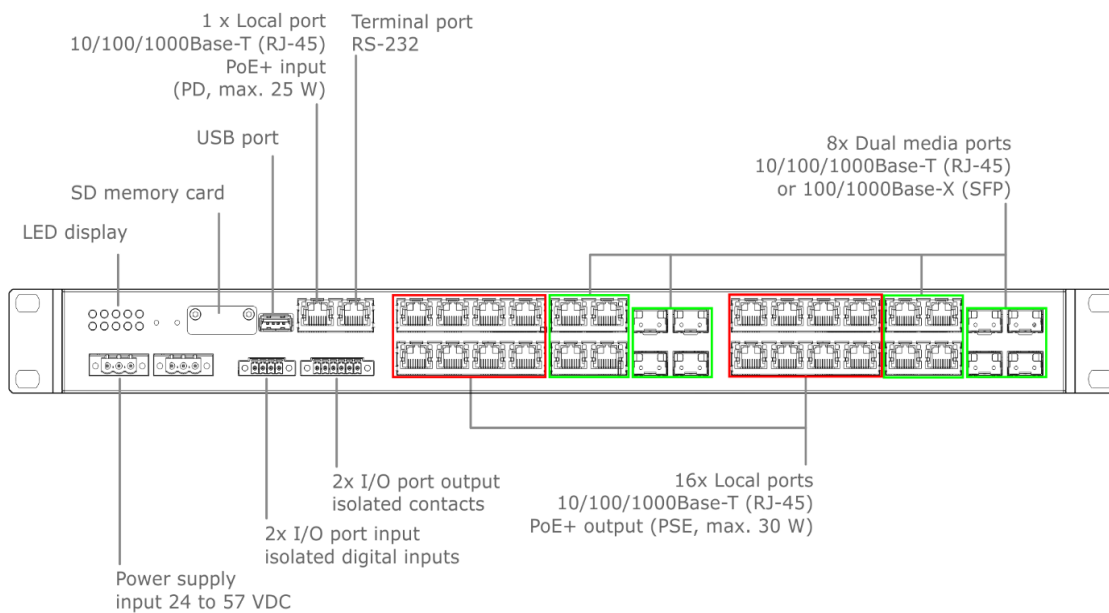

### Rear View:



## Technical Specifications

### Switch

<b>Type</b>	Gigabit Ethernet Switch Layer 2+, IEEE 802.3 compliant
<b>Performance</b>	Store-and-forward Full wire-speed, non-blocking on all ports
<b>MAC addresses</b>	8,192 addresses, automatic learning and aging
<b>Jumbo Frames</b>	max. 10,240 Bytes

### Twisted-Pair Ports

<b>Number</b>	25
<b>Type</b>	Gigabit Ethernet, Triple Speed 10/100/1000Base-T
<b>Connector</b>	RJ-45 port, shielded
<b>Cable type</b>	Twisted-Pair cable, Category 5e, impedance 100 Ohm, length max. 100 m
<b>Flow Control</b>	Pause Frames (IEEE 802.3x), configurable
<b>Pin out</b>	Auto MDI/MDI-X, Auto Polarity
<b>Power-over-Ethernet</b>	Power Sourcing Equipment (PSE) IEEE 802.3af/at Class 0-4, max. 15 W / 30 W

### Fiber Ports (SFP slots)

<b>Number</b>	8
<b>Type</b>	Gigabit Ethernet Dual Speed SFP 100/1000Base-X, support of SFP digital diagnostics function
<b>Connector</b>	LC (SFP transceiver)
<b>Multimode SFP</b> (e.g. MS100200DX)	Multimode, 62.5/125µm (280m) or 50/125 µm (550 m) 850nm wavelength -4..-9.5 dBm output power -18 dBm sensitivity 0 dBm saturation
<b>Single Mode FP</b> (e.g. MS100210DX)	Single Mode, 9/125 µm (10 km) 1310 nm wavelength -3..-9,5 dBm output power -20 dBm sensitivity -3 dBm saturation
<b>Flow Control</b>	Pause Frames (IEEE 802.3x), configurable

### LED displays

<b>Number</b>	Device 10 LEDs Port 2 LEDs per port
<b>LED-modes</b>	<i>Dynamic</i> Standard-mode <i>Static</i> Standard without flash <i>Quiet</i> Only ON- and Sys-LED <i>Dark</i> all LEDs off <i>L-show</i> permanent LED test

#### Port LEDs (integrated in RJ-45)

<b>Ethernet</b>	<i>green</i> Link at port <i>yellow</i> Flashing at data traffic Port blocked (via protocol) <i>red</i> Port Access Control rejected <i>off</i> no link
<b>PoE</b>	<i>green</i> PoE power active <i>yellow</i> PoE not active <i>red</i> PoE failure <i>off</i> PoE deactivated

#### M (Media)

<b>SFP-Port</b> (in use)	<i>green</i> Link at port Flashing at data traffic <i>yellow</i> Port blocked (via protocol) <i>red</i> Port Access Control rejected <i>off</i> no link
--------------------------	---

#### Device LEDs (central)

<b>System 1</b>	<i>active</i> System activities (Firmware update) <i>off</i> Normal operation
<b>System 2</b>	<i>off</i> Normal operation
<b>Power 1/2</b> (Power 1 for MS400895MX)	<i>green</i> Power supply 1/2 OK <i>yellow</i> Input voltage too low/missing
<b>Ring 1/2</b>	<i>green</i> Ring 1/2 normal <i>yellow</i> Ring backup active <i>red</i> Ring backup failure <i>off</i> Ring deactivated
<b>Signal in 1/2</b>	<i>green</i> activated, no signal <i>red</i> S1/S2 activated, alarm <i>off</i> inactive
<b>Signal out 1/2</b>	<i>green</i> activated, no signal <i>red</i> S1/S2 activated, alarm <i>off</i> inactive

### Control Panel

<b>Reset button</b>	Reset of the switch, new upload of the latest stored configuration (direct hardware function)
<b>Factory button</b>	Request of the IP configuration for management, reset back to factory default settings

## Technical Specifications (continued)

### Power Supply

<b>Input</b>	24..57 VDC (54 VDC typ.)
<b>Power Consumption</b>	Typical: 12 W, minimum: 9 W, maximum: 30 W
<b>Connectors</b>	2x 3 pin screw connector or 1x 3 pin screw connector (MS400895MX)

### Power Supply for PoE / PoE+ (PSE) Operation

<b>Input</b>	44..57 VDC PoE: 48 VDC typ. PoE+: 54 VDC typ.
<b>Power Consumption</b>	max. 270 W (incl. PoE+) or max. 510 W (incl. PoE+) (MS400895MX),
<b>Max. PoE Budget</b>	240 W or 480 W (MS400895MX)
<b>Grounding</b>	Plus connector of power supply should be connected to ground (basic recommendation)

### Mechanical

<b>Dimensions</b>	435 x 238 x 43.5 mm (w x d x h, without connectors; width incl. mounting brackets: 481 mm)
<b>Weight</b>	Approx. 3.300g (without SFPs)
<b>Protection Class</b>	IP 30

### Environmental Conditions

<b>Temperature</b>	Operation	-40..+75 °C
	Storage	-40..+85 °C
<b>Note:</b> Maximum continuous operation temperature is up to +75 °C. A maximum ambient temperature of +85°C is permissible for a duration of 24 h if PoE is deactivated.		
<b>Humidity</b>	10..90%, non condensing	
<b>MTBF time</b>	400,000 h	

### Standards

<b>CE</b>	2014/30/EU (EMC Directive) 2011/65/EU (RoHS Directive)
<b>Safety</b>	EN 62368-1
<b>Emitted interference</b>	EN 61000-6-3 EN 55032
<b>Electromagnetic Compatibility</b>	EN 61000-6-2 EN 55024

### Delivery / Contents

#### Standard Packaging

<b>Package unit</b>	1 pcs.
<b>Contents</b>	1x PLR-Switch 1x SD memory card (inserted) 2x power supply connector (1x power supply connector for MS400895MX) 2x I/O connector 1x Quick Start Guide

## Ring-Topology

### Normal operation

- All switches are configured for ring operation
- One switch is assigned as ring master
- Ring master cuts the ring logically

### Ring error

- Switches signalize segment failure via Ethernet (fiber-uplink)
- Master gets that information via Ethernet and closes the logical cut
- Switches re-learn the current network topology (MAC-addresses)
- Network function is re-established in less than 50 ms

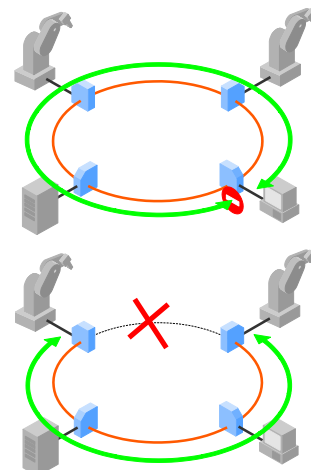

# Dimensions (MS400890MX-V2)

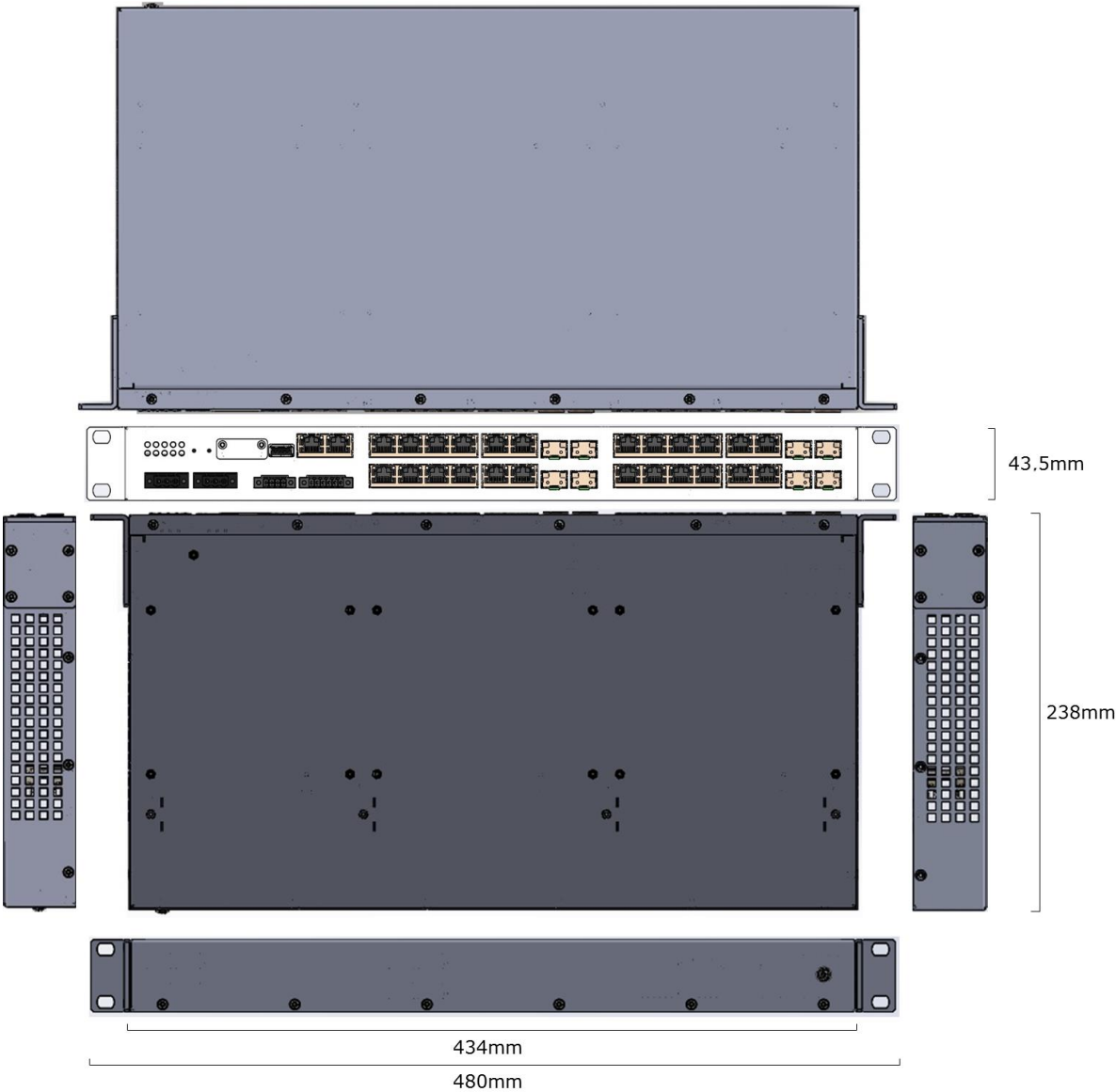

## Memory Card (MS400890MX-V2)

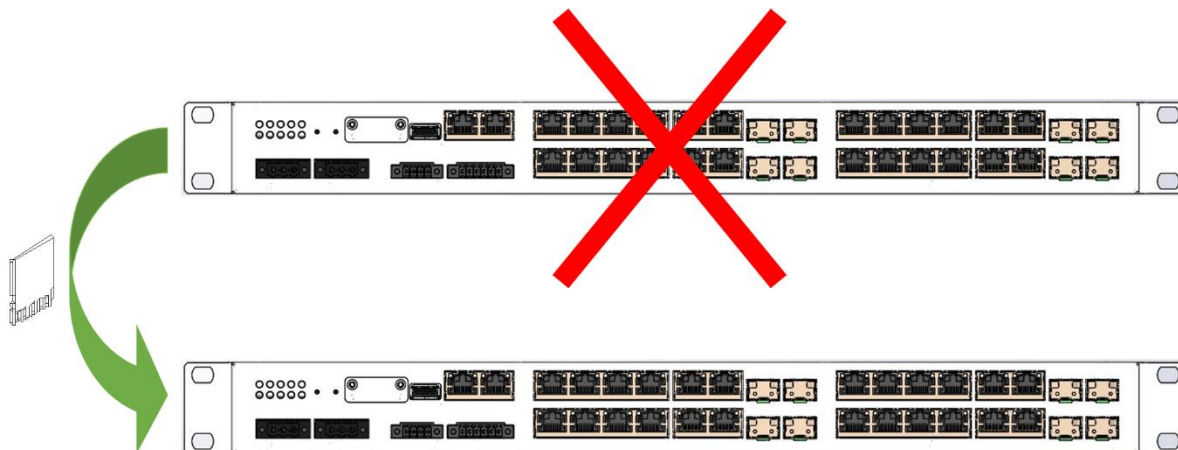

### SD Memory Card

The included SD memory card is used for the permanent storage of configuration, script and firmware files. With this memory card it is possible to transfer a configuration to a new device in case of a device failure.

Optionally it is possible to write an own MAC address to the SD memory card. This one has priority compared to the MAC address in the switch. This allows to provide an exact clone of the device by swapping the memory card.

- Change of memory card transfers the *complete* device status
- Fault tolerant journaling file system
- Industrial grade-long term stability
- Only MICROSENS memory cards have to be used. Only with these the long term stability over the complete temperature range can be ensured.

## Alarm Contacts (MS400890MX-V2)

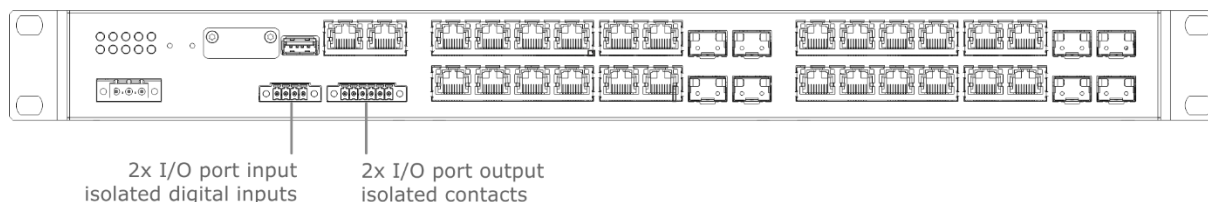

### Galvanic isolated contacts (2x)

The potential free output contacts (I/O out) allow to control external signalling devices to show the alarm and operation status.

- Relay contact, maximum load 57 V/1 A
- Isolation voltage to the device 1500 VDC
- Normally open (NO) and normally closed (NC) contact possible
- The signal status is indicated by an LED
- **Attention:** Not suitable for the direct connection of 230 VAC devices!

### Galvanic isolated digital inputs (2x)

The potential free input contacts (I/O in) allow the direct monitoring of external systems, e.g. a rack or door monitoring system.

- 2x galvanic isolated, digital input
- Internal optocoupler, Input voltages greater than 12 VDC require a serial resistor.  
Valid Voltage ranges:
  - 0 – 12 VDC: no serial resistor
  - up to 15 VDC: 300  $\Omega$
  - up to 24 VDC: 1.2 k $\Omega$
  - up to 36 VDC: 2.4 k $\Omega$
  - up to 48 VDC: 3.6 k $\Omega$
  - up to 57 VDC: 4,7 k $\Omega$
- Isolation voltage 1500 VDC
- Status monitored via management



## Gigabit Ethernet Ports (MS400890MX-V2)

### Front View:

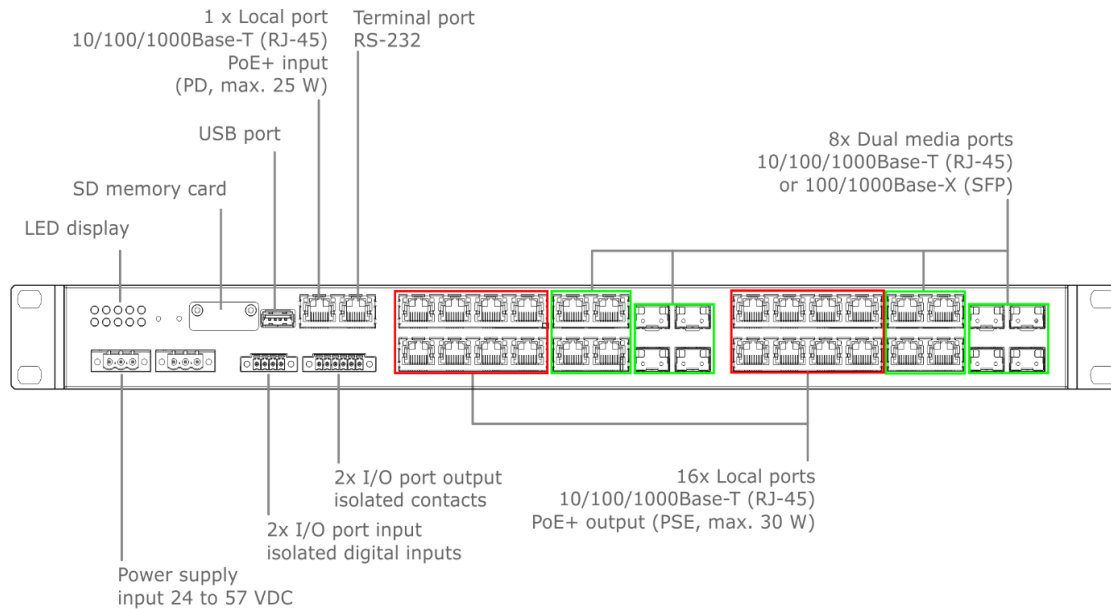

### Rear View:



#### **Gigabit Ethernet Ports (RJ-45)**

All Gigabit Ethernet ports are for the connection of 10, 100 or 1000 Mbps segments via twisted pair cables with RJ-45 connectors.

The integrated auto negotiation and auto crossover functions automatically ensure the best connection method to the end devices.

#### **1x Local Port, PD (RJ-45)**

This port additional includes a PoE+ powered device (PD) input. Via this port the switch can be supplied with electrical power. The power which is not required by the switch itself can be supplied to the end devices via its PoE+ ports.

#### **16x Local Ports, PSE (RJ-45)**



These ports additional include PoE+ Power Sourcing Equipment (PSE) functionality. With this the switch can supply the connected end devices with electrical power. This is often used for VoIP-telephones, IP-cameras and WLAN-Access Points

#### **8x Dual Media Ports (RJ-45/SFP)**

These ports can be optionally used with twisted pair or fiber cables. For the use of a fiber cable a suitable SFP must be plugged into the switch.

The selection of the used media (twisted pair or fiber) can be made by the management.



## Order Information

	Description	Article No.:
	<b>Ruggedized 19" Gigabit Ethernet Switch with PoE+</b>	
	25-Port GbE Industrial PLR Switch 19" PoE+ 8x 100/1000X SFP-Slots or 10/100/1000T (Combo), 17x 10/100/1000T, 16x PoE+, 1x PD+, 2x 24..57VDC, 19", managed, USB, sd-card incl., 2x I/O, RS-232 Port (RJ-45)	<b>MS400890MX-V2</b>
	25-Port GbE Industrial PLR Switch 19" PoE+ 480W 8x 100/1000X SFP-Slots or 10/100/1000T (Combo), 17x 10/100/1000T, 16x PoE+, 1x PD+, 24..57VDC, 19", managed, USB, sd-card incl., 2x I/O, RS-232 Port (RJ-45), max. PSE-Budget 480W	<b>MS400895MX</b>

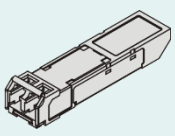
## Accessories

	Description	Article No.:
	<b>Additional Memory Cards for Profi Line Modular Base Switch</b>	
	SD memory card for MICROSENS PLM-Switches, Extended temperature range -25°C up to +85°C	<b>MS140890X-4GB</b>
	<b>SFP Transceiver (Fast Ethernet &amp; WDM on request)</b>	
	SFP Transceiver, Gigabit Ethernet, Digital Diagnostic 850 nm Multimode, 1000Base-SX, LC duplex Extended temperature range -25°C up to +85°C	<b>MS100200DX</b>
	SFP Transceiver, Gigabit Ethernet, Digital Diagnostic 1310 nm Monomode, 1000Base-LX, LC duplex Extended temperature range -25°C up to +85°C	<b>MS100210DX</b>

## Accessories (continued)

	<b>NMP 2.x Network Management***</b>	
	NMP 2.x Enterprise Basic package incl. 1 x usage right for NMP Enterprise, 200 x usage rights f. NMP Enterprise Managed Objects, and SW Maintenance for 1 year (download of updates), installation of server SW on max. 1 computer, electronic user manual included	<b>MS200100</b>
	NMP 2.x Enterprise Basic package incl. 1 x usage right for NMP Enterprise, 1000 x usage rights f. NMP Enterprise Managed Objects, and SW Maintenance for 1 year (download of updates), installation of server SW on max. 1 computer, electronic user manual included	<b>MS200102</b>
	<b>External Power Supplies for industrial use 24 VDC</b>	
	Industrial DIN-Rail Power Supply 24VDC/1,25A (30W) Input 100..240VAC/120..375VDC, Output: 24..28VDC, -20..+70°C	<b>MS700440</b>
(Model: MS700456)		

 (Model: MS700456)	<b>External Power Supplies for industrial use with PoE / PoE+ 44..57VDC (continued)</b>	
	DIN Rail Power Supply 60 Watt 48 VDC / 1.25 A, Adjustment range 48..56VDC Wide input range 85..264 VAC	<b>MS700430</b>
	DIN Rail Power Supply, 45..55 VDC / 2.5 A (120W), Wide input range 90..132/180..264 VAC Operating temperature range -35..+70°C	<b>MS700456</b>
	DIN Rail Power Supply 47..56 VDC / 5 A (240W) Wide input range 90..132/180..264 VAC For extended temperature range -40..+70°C	<b>MS700457</b>

## Service

Description	Art.-No.
<b>Warranty Extension following the 24-Month Manufacturer Warranty**</b>	
1 year warranty extension	<b>MSGV01</b>
2 year warranty extension	<b>MSGV02</b>
3 year warranty extension	<b>MSGV03</b>
<b>Custom-made pre-configuration</b>	
Custom-made pre-configuration of a component	<b>MSKonfig</b>
Custom-made pre-configuration (configuration file already available)	<b>MSKonfig-OK</b>

\*\* **Manufacturer Warranty** is defined in [General Terms and Conditions of Sale \(§9\)](#) of MICROSENS GmbH & Co. KG.  
 \*\*\* Please refer to separate data sheets to obtain detailed information on the listed variants.

This document in whole or in part may not be duplicated, reproduced, stored or retransmitted without prior written permission of MICROSENS GmbH & Co. KG. All information in this document is provided 'as is' and subject to change without notice. MICROSENS GmbH & Co. KG disclaims any liability for the correctness, completeness or quality of the information provided, fitness for a particular purpose or consecutive damage. MICROSENS is a trademark of MICROSENS GmbH & Co. KG. Any product names mentioned herein may be trademarks and/or registered trademarks of their respective companies. 2021-01-26/WF/AL