

Data Sheet

Profi Line+

Industrial Gigabit Ethernet Ring-Switch



Overview

The Industrial Ethernet Switch Profi Line+ from MICROSENS offers best performance in compact design. Robust and designed for greatest reliability and shortest recovery times, the Profi Line+ has become a first-choice solution for Industrial Ethernet. The hardware of the Profi Line+ is designed for future functions which are easy to activate by applying firmware upgrades. This is facilitated through a high-performance switching chipset in combination with a powerful ARM processor. As an established, stable operating system, Linux offers a solid foundation for an intelligent, open and long-term reliable platform.

Highlights

- Highest Gigabit performance with smallest dimensions
- Industrial design for maximum reliability in harsh environments
- Compact design with full Gigabit performance
- PoE+ integrated
- Exchangeable SD-card for firmware and configuration included
- Flexible firmware architecture for simple software upgrades
- Redundant power inputs

Specifications

Gigabit Ethernet Switch

- Fanless Gigabit Ethernet Switch
- Low power consumption switch-chipset, Energy-Efficient Ethernet
- Layer-2+ store-and-forward
- Max. 8,192 MAC-addresses, automatic learning and aging
- Jumbo-Frames (max. 10,240 Bytes)

Energy-Efficient Ethernet

- EEE according to IEEE 802.3az
- Reduced power consumption for each RJ-45 port up to 80% depending on the actual requirement

Network Management

- Support of common management standards
- High Performance 1000 MHz ARM CPU and Linux operating system with fast system boot
- Web Manager (HTTP/HTTPS)
- Telnet/SSH/Console, incl. standard-commands (ping, traceroute etc.)
- SNMP v1/v2c/v3 with View-based Access Control Model (VACM) and User-based Security Model (USM)
- Central management platform (MICROSENS NMP)
- IPv4/IPv6 Dual Stack
- Integrated CLI scripting for the automation of routine processes
- Firmware-, script- and configuration files can be loaded, stored and executed directly from the switch
- Incremental firmware updates
- Exchangeable SD memory card for configuration, CLI scripts, firmware

Compatibility

- Verified to standard CISCO Switches (IEEE 802.1X, QoS, VLAN, CDP, RSTP)

Power-over-Ethernet PoE/PoE+

- 4x 10/100/1000Base-T, PoE/PoE+ (PSE, max. 30 W)
- 1x 10/100/1000Base-T, PoE+ (PD, max. 25 W)
- IEEE 802.3af PoE (max. 15 W/Port), power supply with typ. 48 VDC
- IEEE 802.3at PoE+ (max. 30 W/Port), power supply with typ. 54 VDC
- Max. PoE Budget: 120 W
- Full power available under suitable installation conditions only

Connectors (Base-Switch)

Up-/Downlinks (Dual Media-Ports)

- 2x SFP-Slot 100/1000Base-X
- or
- 2x 10/100/1000Base-T (RJ-45)

Local Ports

- 5x 10/100/1000Base-T (RJ-45) Auto-Negotiation
- Auto MDI/MDI-X function for the use of uniform patch cables

Power Supply

- 2x 3-pin screw pluggable connector for solid or stranded wires

RS-232 Console Port

- Serial terminal port for CLI access (outband management)
- RJ-45 connector

USB Extension Port

- For optional accessories

Alarm Contacts / I/O-Ports

- Potential free digital input/output ports
- 2x output (relay)
- 2x input (optocoupler)

Mounting

- Integrated holder for DIN-rails (DIN EN 50022)

Feature overview network management

For the latest functional firmware features and supported IEEE / RFC standards, please refer to the document "[Firmware Features G6](#)" which can be downloaded from the download center of the particular device home pages at www.microsens.de

Interfaces

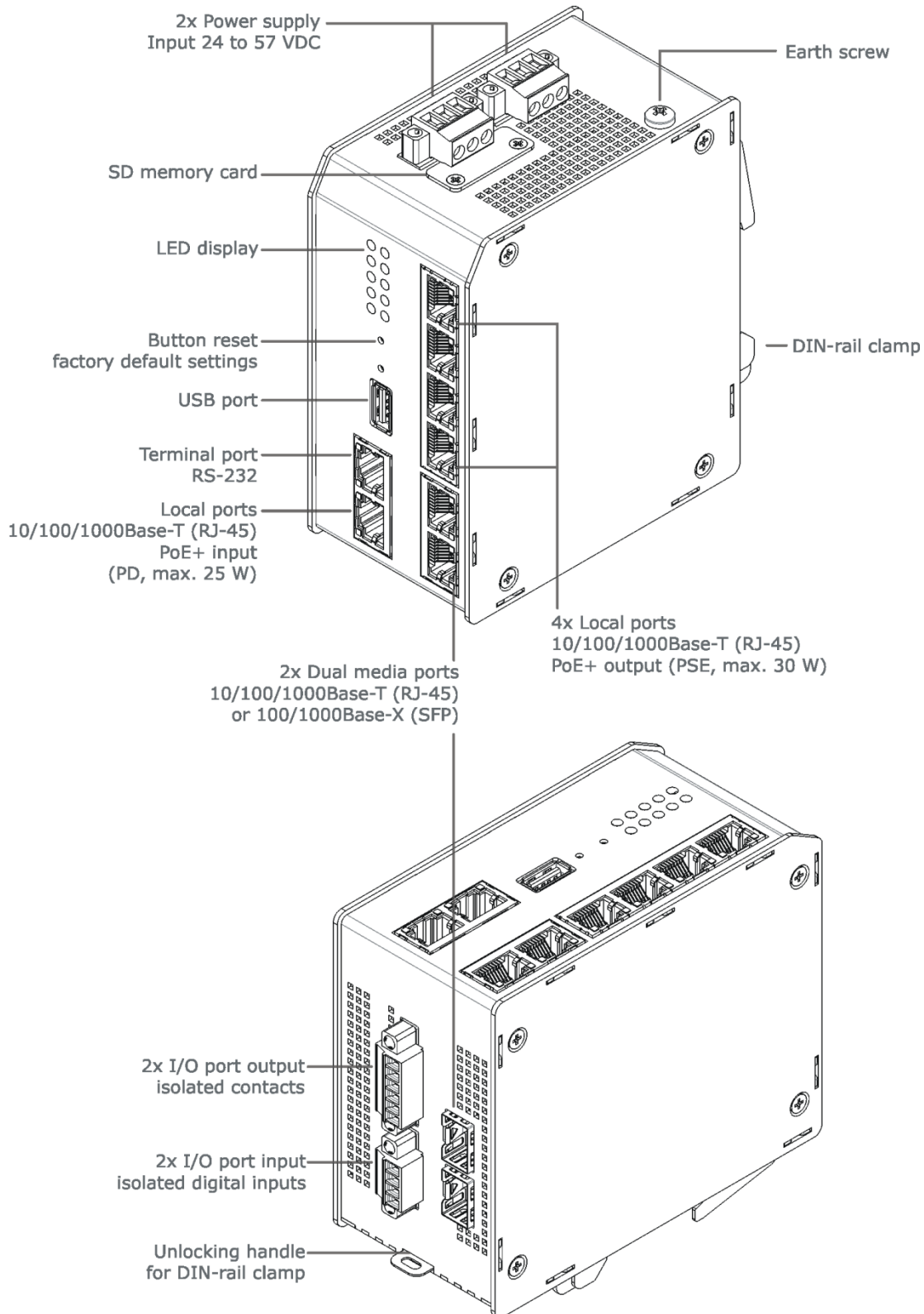

Technical Specifications

Switch

Type	Gigabit Ethernet Switch Layer 2+, IEEE 802.3 compliant
Performance	Store-and-forward Full wire-speed, non-blocking on all ports
MAC addresses	8,192 addresses, automatic learning and aging
Jumbo Frames	max. 10,240 Bytes

Twisted-Pair Ports

Number	7
Type	Gigabit Ethernet, Triple Speed 10/100/1000Base-T
Connector	RJ-45 port, shielded
Cable type	Twisted-Pair cable, Category 5e, impedance 100 Ohm, length max. 100 m
Flow Control	Pause Frames (IEEE 802.3x), configurable
Pin out	Auto MDI/MDI-X, Auto Polarity
Power-over-Ethernet	Power Sourcing Equipment (PSE) IEEE 802.3af/at Class 0-4, max. 15 W / 30 W

Fiber Ports (SFP slots)

Number	2
Type	Gigabit Ethernet Dual Speed SFP 100/1000Base-X, support of SFP digital diagnostics function
Connector	LC (SFP transceiver)
Multimode SFP (e.g. MS100200DX)	Multimode, 62.5/125µm (280m) or 50/125 µm (550 m) 850nm wavelength -4..-9.5 dBm output power -18 dBm sensitivity 0 dBm saturation
Single Mode FP (e.g. MS100210DX)	Single Mode, 9/125 µm (10 km) 1310 nm wavelength -3..-9,5 dBm output power -20 dBm sensitivity -3 dBm saturation
Flow Control	Pause Frames (IEEE 802.3x), configurable

LED displays

Number	Device 10 LEDs Port 2 LEDs per port
LED-modes	<i>Dynamic</i> Standard-mode <i>Static</i> Standard without flash <i>Quiet</i> Only ON- and Sys-LED <i>Dark</i> all LEDs off <i>L-show</i> permanent LED test

Port LEDs (integrated in RJ-45)

Ethernet	<i>green</i> Link at port <i>yellow</i> Flashing at data traffic Port blocked (via protocol) <i>red</i> Port Access Control rejected <i>off</i> no link
PoE	<i>green</i> PoE power active <i>yellow</i> PoE not active <i>red</i> PoE failure <i>off</i> PoE deactivated

M (Media)

SFP-Port (in use)	<i>green</i> Link at port Flashing at data traffic <i>yellow</i> Port blocked (via protocol) <i>red</i> Port Access Control rejected <i>off</i> no link
--------------------------	---

Device LEDs (central)

System 1	<i>active</i> System activities (Firmware update) <i>off</i> Normal operation
System 2	<i>off</i> Normal operation
Power 1/2	<i>green</i> Power supply 1/2 OK <i>yellow</i> Input voltage too low/missing
Ring 1/2	<i>green</i> Ring 1/2 normal <i>yellow</i> Ring backup active <i>red</i> Ring backup failure <i>off</i> Ring deactivated
Signal in 1/2	<i>green</i> activated, no signal <i>red</i> S1/S2 activated, alarm <i>off</i> inactive
Signal out 1/2	<i>green</i> activated, no signal <i>red</i> S1/S2 activated, alarm <i>off</i> inactive

Control Panel

Reset button	Reset of the switch, new upload of the latest stored configuration (direct hardware function)
Factory button	Request of the IP configuration for management, reset back to factory default settings

Technical Specifications (continued)

Power Supply

Input	24..57 VDC (54 VDC typ.) min. 44 VDC for PoE operation
Power Consumption	Typical: 9 W, minimum: 7 W, maximum: 30 W
Connectors	2x 3 pin screw connector

Power Supply for PoE / PoE+ (PSE) Operation

Input	44..57 VDC PoE: 48 VDC typ. PoE+: 54 VDC typ.
Power Consumption	max. 135 W (incl. PoE+)
Max. PoE Budget	120 W
Grounding	Plus connector of power supply should be connected to ground (basic recommendation)

Mechanical (Base Unit)

Dimensions	120.5 mm x 59.7 mm x 100.5 mm (w x d x h, without connectors)
Weight	Approx. 790g (without SFPs)
Protection Class	IP 30

Environmental Conditions

Temperature	Operation	-40..+75 °C
	Storage	-40..+85 °C
Humidity	10..90%, non condensing	
MTBF time	400,000 h	

Standards

CE	2014/30/EU (EMC Directive) 2011/65/EU (RoHS Directive)
Safety	EN 62368-1
Emitted interference	EN 61000-6-3 EN 55032
Electromagnetic Compatibility	EN 61000-6-2 EN 55024

Delivery / Contents

<i>Standard Packaging</i>	
Package unit	1 pcs.
Contents	1x PL+-Switch 1x SD memory card (inserted) 2x power supply connector 2x I/O connector 1x Quick Start Guide

Ring-Topology

Normal operation

- All switches are configured for ring operation
- One switch is assigned as ring master
- Ring master cuts the ring logically

Ring error

- Switches signalize segment failure via Ethernet (fiber-uplink)
- Master gets that information via Ethernet and closes the logical cut
- Switches re-learn the current network topology (MAC-addresses)
- Network function is re-established in less than 50 ms

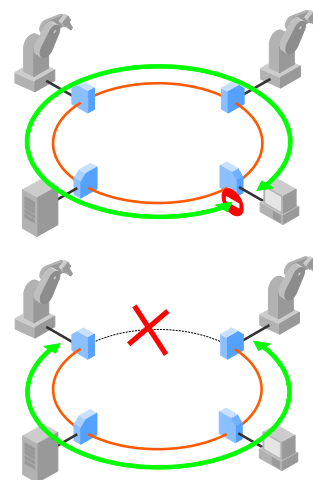

Dimensions

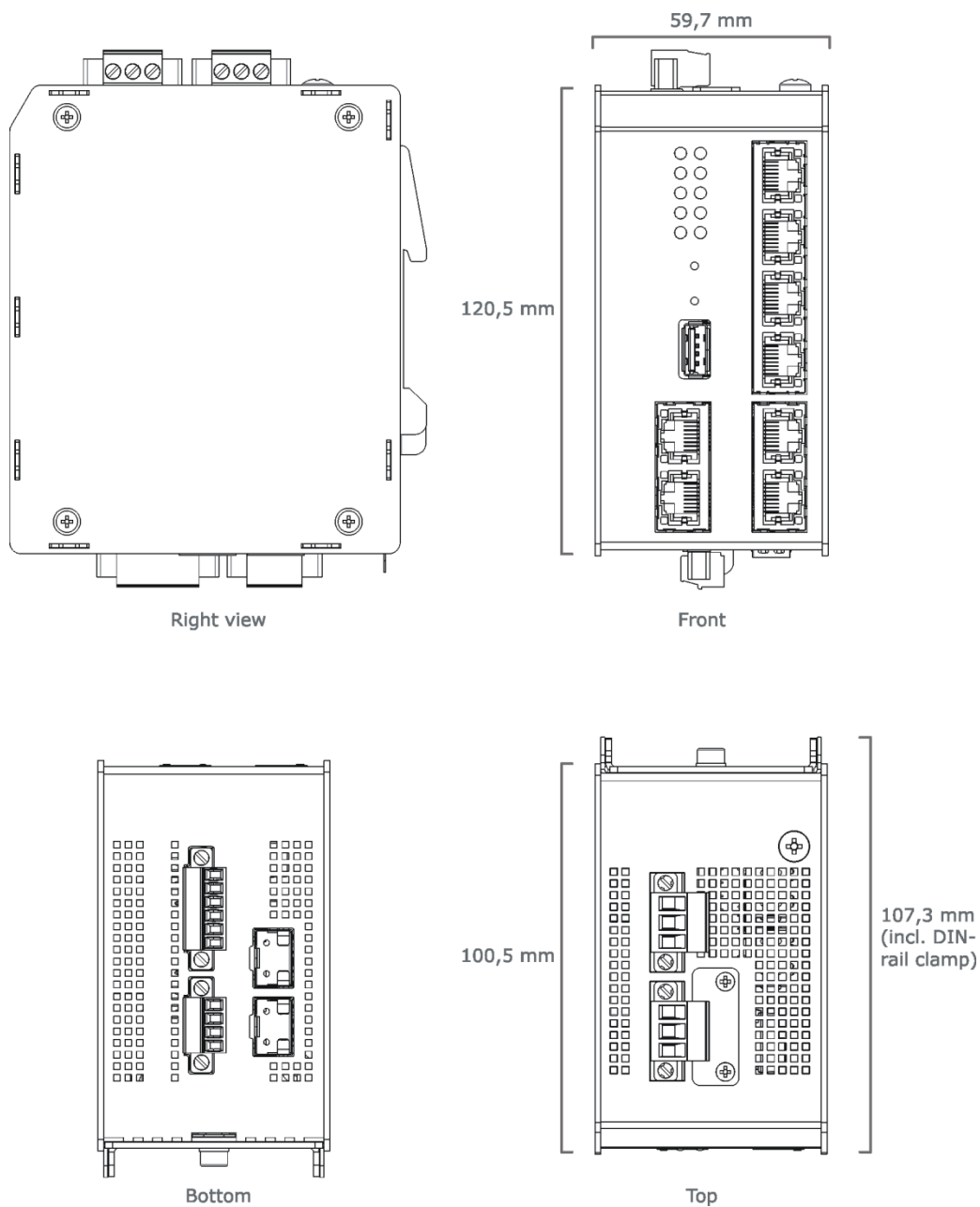

Height: 120.5 mm (Without connectors)
 Width: 59.7 mm
 Depth: 100.5 mm (107.3 mm incl. DIN-rail holder)

Memory Card

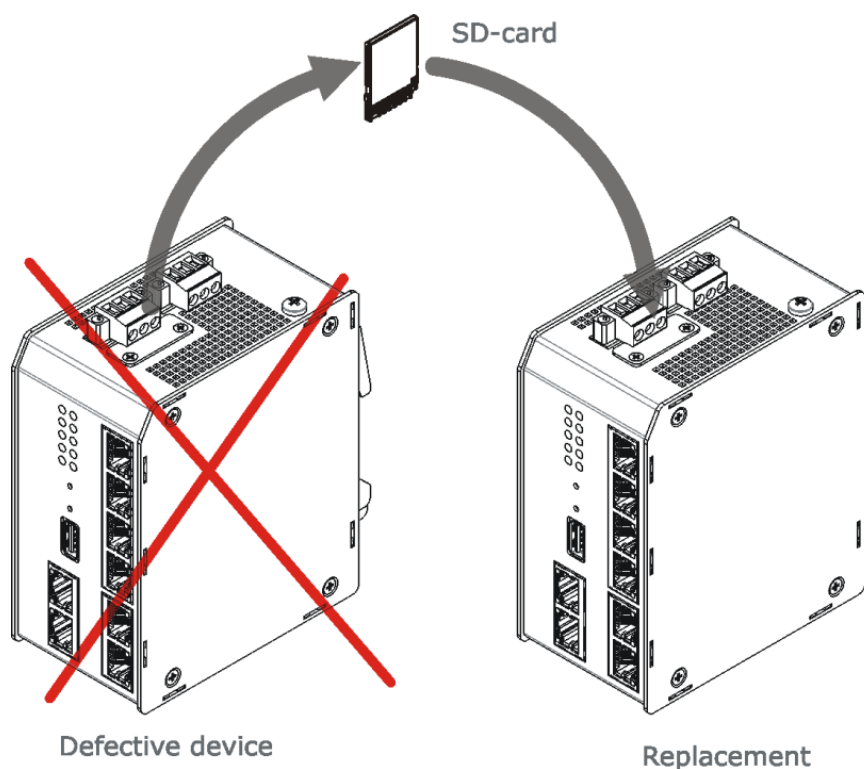

SD Memory Card

The included SD memory card is used for the permanent storage of configuration, script and firmware files. With this memory card it is possible to transfer a configuration to a new device in case of a device failure.

Optionally it is possible to write an own MAC address to the SD memory card. This one has priority compared to the MAC address in the switch. This allows to provide an exact clone of the device by swapping the memory card.

- Change of memory card transfers the *complete* device status
- Fault tolerant journaling file system
- Industrial grade-long term stability
- Only MICROSENS memory cards have to be used. Only with these the long term stability over the complete temperature range can be ensured.

Alarm Contacts

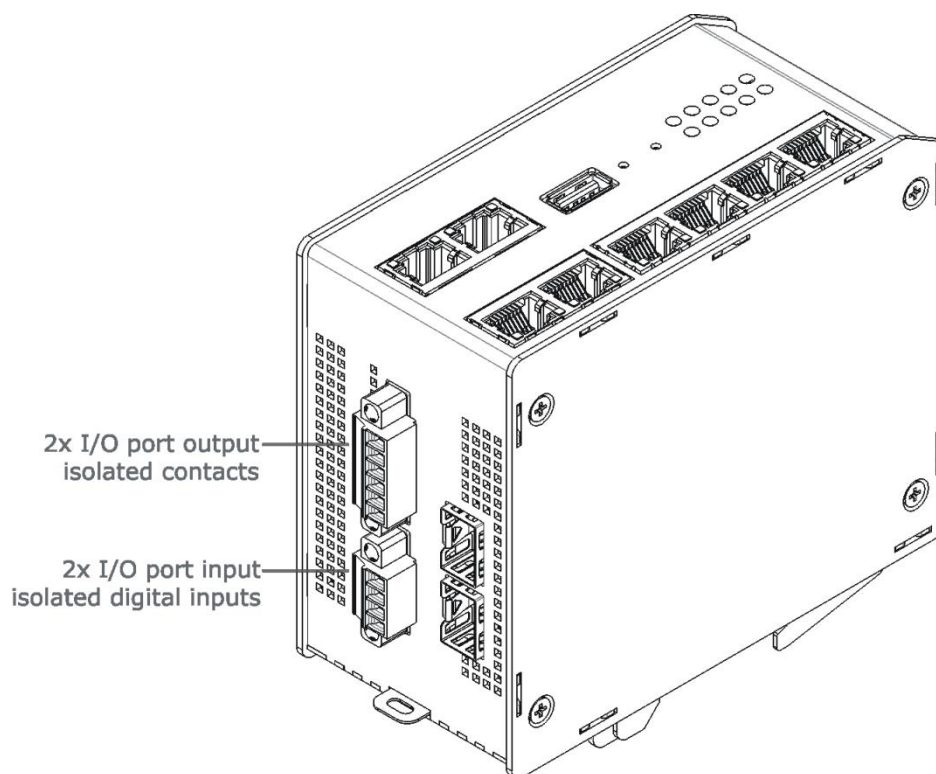

Galvanic isolated contacts (2x)

The potential free output contacts (I/O out) allow to control external signalling devices to show the alarm and operation status.

- Relay contact, maximum load 57 V/1 A
- Isolation voltage to the device 1500 VDC
- Normally open (NO) and normally closed (NC) contact possible
- The signal status is indicated by an LED
- Attention: Not suitable for the direct connection of 230 VAC devices!

Galvanic isolated digital inputs (2x)

The potential free input contacts (I/O in) allow the direct monitoring of external systems, e.g. a rack or door monitoring system.

- 2x galvanic isolated, digital input
- Internal optocoupler, Input voltages greater than 12 VDC require a serial resistor.
Valid Voltage ranges:
 - 0 – 12 VDC: no serial resistor
 - up to 15 VDC: 300 Ω
 - up to 24 VDC: 1.2 k Ω
 - up to 36 VDC: 2.4 k Ω
 - up to 48 VDC: 3.6 k Ω
 - up to 57 VDC: 4,7 k Ω
- Isolation voltage 1500 VDC
- Status monitored via management

Gigabit Ethernet Ports

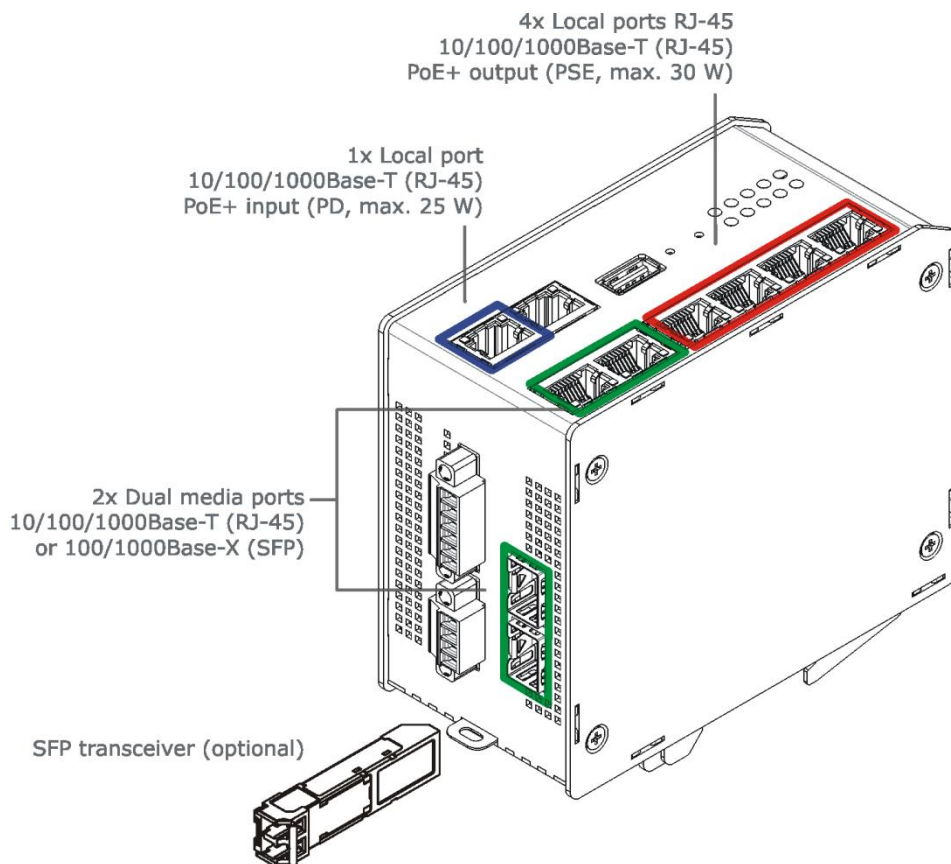

Gigabit Ethernet Ports (RJ-45)

All Gigabit Ethernet ports are for the connection of 10, 100 or 1000 Mbps segments via twisted pair cables with RJ-45 connectors.

The integrated auto negotiation and auto crossover functions automatically ensure the best connection method to the end devices.

2x Dual Media Ports (RJ-45/SFP)

These ports can be optionally used with twisted pair or fiber cables. For the use of a fiber cable a suitable SFP must be plugged into the switch.

The selection of the desired or preferred media (twisted pair or fiber) can be made by the management.

4x Local Ports, PSE (RJ-45)

Additionally, these ports include PoE+ Power Sourcing Equipment (PSE) functionality. With this the switch can supply the connected end devices with electrical power. This is often used for VoIP-telephones, IP-cameras and WLAN-Access Points

1x Local Port, PD (RJ-45)

This port includes a PoE+ powered device (PD) input. Via this port the switch can be supplied with electrical power. The power which is not required by the switch itself can be supplied to the end devices via its PoE+ ports.



Order Information

	Description	Article No.:
	Profi Line+ Switch	
	Industrial Gigabit Ethernet Switch, 5x 10/100/1000Base-T PoE/PoE+ (4x PSE / 1x PD), 2x Dual Media Ports: 100/1000Base-X SFP-Slot or 10/100/1000Base-T, Power supply input 24..57 VDC	MS650919PM

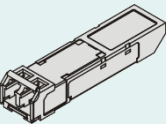
Accessories

	Description	Article No.:
	Additional Memory Cards for Profi Line+	
	SD memory card for MICROSENS PLM-Switches, Extended temperature range -25°C up to +85°C	MS140890X-4GB
	SFP Transceiver (Fast Ethernet & WDM on request)	
	SFP Transceiver, Gigabit Ethernet, Digital Diagnostic 850 nm Multimode, 1000Base-SX, LC duplex Extended temperature range -25°C up to +85°C	MS100200DX
	SFP Transceiver, Gigabit Ethernet, Digital Diagnostic 1310 nm Monomode, 1000Base-LX, LC duplex Extended temperature range -25°C up to +85°C	MS100210DX

Accessories (continued)

	NMP 2.x Network Management***	
	NMP 2.x Enterprise Basic package incl. 1 x usage right for NMP Enterprise, 200 x usage rights f. NMP Enterprise Managed Objects, and SW Maintenance for 1 year (download of updates), installation of server SW on max. 1 computer, electronic user manual included	MS200100
	NMP 2.x Enterprise Basic package incl. 1 x usage right for NMP Enterprise, 1000 x usage rights f. NMP Enterprise Managed Objects, and SW Maintenance for 1 year (download of updates), installation of server SW on max. 1 computer, electronic user manual included	MS200102
	External Power Supplies for industrial use 24 VDC	
 (Model: MS700456)	DIN Rail Power Supply 24 Watt 24 VDC / 1.0 A, Wide input range 85..264 VAC, 85...375 VDC	MS700420
	External Power Supplies for industrial use with PoE / PoE+ 44..57VDC	
	DIN Rail Power Supply 60 Watt 48 VDC / 1.25 A, Adjustment range 48..56VDC Wide input range 85..264 VAC	MS700430

External Power Supplies for industrial use with PoE / PoE+ 44..57VDC (continued)	
DIN Rail Power Supply, 45..55 VDC / 2.5 A (120W), Wide input range 90..132/180..264 VAC Operating temperature range -35..+70°C	MS700456
DIN Rail Power Supply 47..56 VDC / 5 A (240W) Wide input range 90..132/180..264 VAC For extended temperature range -40..+70°C	MS700457

Alternative products

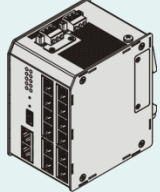
	Description	Article No.:
	19" Profi Line Rack Switch (with PoE+) 25-Port GbE Industrial PLR Switch 19" PoE+ 8x 100/1000X SFP-Slots or 10/100/1000T (Combo), 17x 10/100/1000T, 16x PoE+, 1x PD+, 2x 24..57VDC, 19", managed, USB, SD-card incl., 2x I/O, RS-232 Port (RJ-45)	MS400890MX-V2
	Prof Line Modular Switch (with PoE+) 13-Port GbE Industrial PLM Switch PoE+ 4x 100/1000X SFP-Slots or 10/100/1000T (Combo), 9x 10/100/1000T, 8x PoE+, 1x PD+, 2x 24..57VDC, DIN-Rail, managed, USB, SD-card incl., 2x I/O, RS-232 Port (RJ-45)	MS652119PM-V2

Service

Description	Art.-No.
Warranty Extension following the 24-Month Manufacturer Warranty**	
1 year warranty extension	MSGV01
2 year warranty extension	MSGV02
3 year warranty extension	MSGV03
Custom-made pre-configuration	
Custom-made pre-configuration of a component	MSKonfig
Custom-made pre-configuration (configuration file already available)	MSKonfig-OK

** **Manufacturer Warranty** is defined in [General Terms and Conditions of Sale \(§9\)](#) of MICROSENS GmbH & Co. KG.

*** Please refer to separate data sheets to obtain detailed information on the listed variants.

This document in whole or in part may not be duplicated, reproduced, stored or retransmitted without prior written permission of MICROSENS GmbH & Co. KG. All information in this document is provided 'as is' and subject to change without notice. MICROSENS GmbH & Co. KG disclaims any liability for the correctness, completeness or quality of the information provided, fitness for a particular purpose or consecutive damage. MICROSENS is a trademark of MICROSENS GmbH & Co. KG. Any product names mentioned herein may be trademarks and/or registered trademarks of their respective companies. 2021-01-25/WF/AL